

MODEL B662



DESCRIPTION

The 12 key Z-series keypads are specially designed for public environment applications, such as vending machines, ticket machines, payment terminals, telephones, access control systems and industrial machinery.

Keys are built from chrome plated zinc alloy (Zamak) with high resistance to impact and vandalism and is also sealed to IP65.

1 MAIN COMPONENTS

- Keys are made of RoHS approved zinc alloy material and frame is made of ABS material.
- Conductive rubber with carbon granules
 - Contact resistance: $\leq 150\Omega$
 - Elastic force: 200g
- 1.5mm thickness UL approved printed circuit board with golden fingers

2 STRUCTURE DRAWING

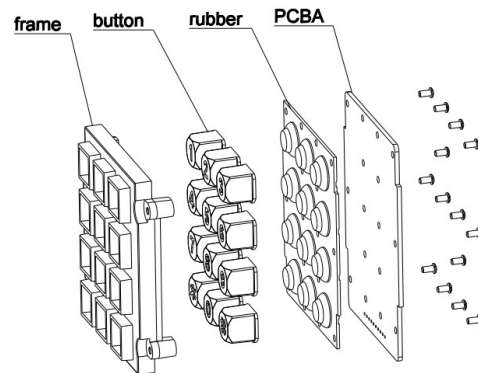

3 DIMENSION DRAWING

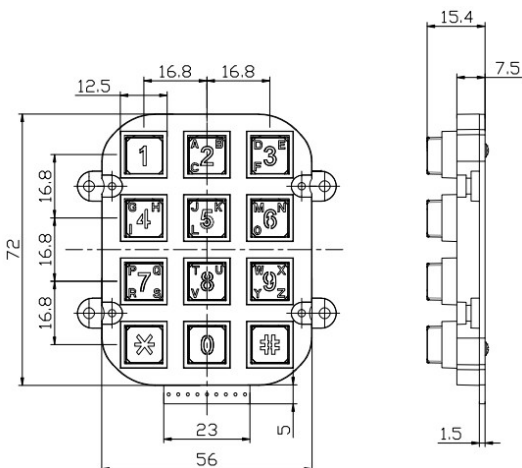

4 COMMON CIRCUIT

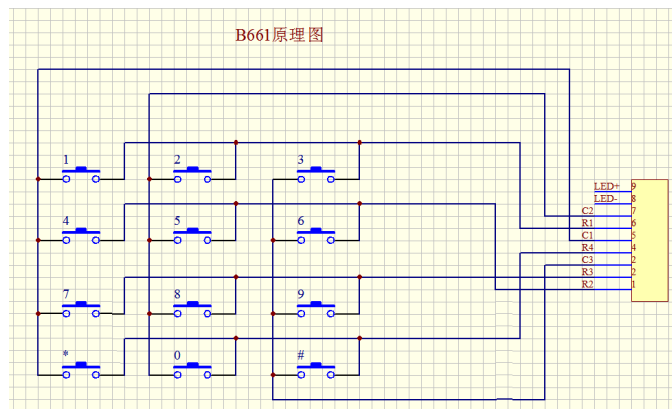

5 SPECIFICATION

Electrical Specification	Power Supply	Nominal 3 VDC
		Max. voltage 12VDC
		Min. voltage 3VDC
	Power Supply	Min. Current 60mA
Mechanical Characteristics		Standard blue color and white, yellow, green and white color are optional.
	Contact Resistance	≤150Ω
	Storage Temperature	-40℃ ... +85℃
	Operation Temperature	-25℃ ... +65℃
	Protection Grade	IP65
	Shock Resistance	IK09
	Electrical Life	1 million cycles of operation per key
	Key Travel	0.45mm
Environmental Resistance		Damp heat 21 days +40℃
		Saline mist 96 Hours
		Dry heat 10 days +85℃

6 CONNECTOR

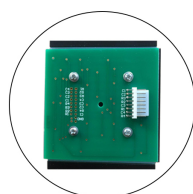

Plug Connector

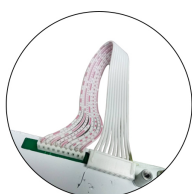

SCN plug+cable



XH plug+cable

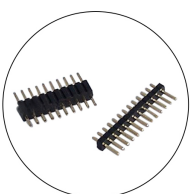

Pins header



DB9 Connector



USB

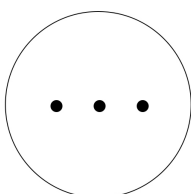

More

7 APPLICATION

